



# RCA Television PARTS

FOR KINESCOPE DEFLECTING CIRCUITS

Again RCA encourages the amateur and experimenter by making available the basic units for the construction of Kinescope deflecting circuits. These parts are of traditional RCA design, include the finest engineering features and are manufactured to give long and faithful service. They are for use with RCA 5- and 9-inch Kinescopes, Nos. 1800 and 1801 in the circuits shown on Page 4. All transformers and reactors have leads 6 inches long.



## DEFLECTING YOKE

For RCA 1800 and 1801 Kinescopes. Has windings for both horizontal and vertical deflecting circuits. Designed to have uniform flux distribution. Size: Outside diameter  $2\frac{1}{2}$  inches; Inside diameter to fit RCA 1800 and 1801 Kinescopes; length  $3\frac{3}{4}$  inches. See Figure 1.

Stock No. 9831

Net Price \$10.00

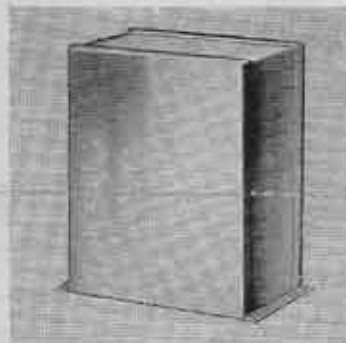

## POWER TRANSFORMER

For RCA 1800 Kinescope. Includes all windings necessary for a complete power supply for the anode and heater circuit of the 1800 Kinescope. Plate winding of 4,500 volts and two 2.5 volt heater windings. Entire transformer insulated for high voltage. Size: H.  $6\frac{1}{8}$ ", W.  $5\frac{1}{8}$ ", D.  $3\frac{3}{8}$ ". See Figures 2 and 3.

Stock No. 9832

Net Price \$12.50

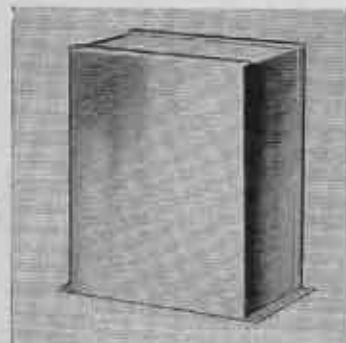

## POWER TRANSFORMER

For RCA 1801 Kinescope. Includes all windings necessary for complete power supply for the anode and heater circuit of the 1801 Kinescope. Plate winding of 2,300 volts and two 2.5 volt heater windings, adequately insulated. Size: H.  $6\frac{1}{8}$ ", W.  $5\frac{1}{8}$ ", D.  $3\frac{3}{8}$ ". See Figures 4 and 5.

Stock No. 9839

Net Price \$10.00

Fig. 1



Fig. 2

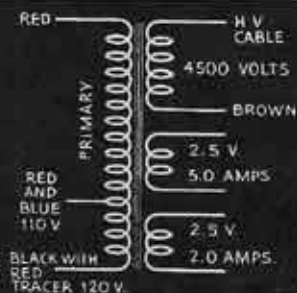

Fig. 3

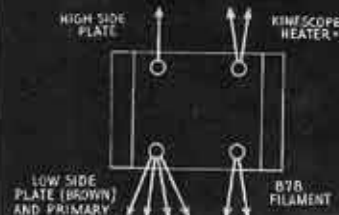

Fig. 4

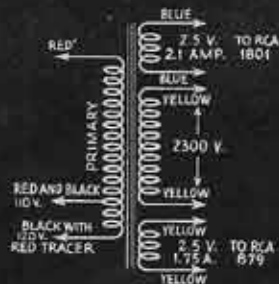
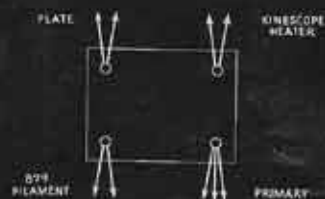

Fig. 5





## VERTICAL OUTPUT REACTOR

A high-quality auto-transformer for matching the output of deflecting circuits to the deflecting yoke vertical circuit. 120 henries inductance. 3800 ohms d-c resistance. Size: H.  $2\frac{3}{4}$ ", Base  $2\frac{1}{4}$ " square, Diameter  $2\frac{1}{8}$ ".

Stock No. 9833

Net Price \$3.00

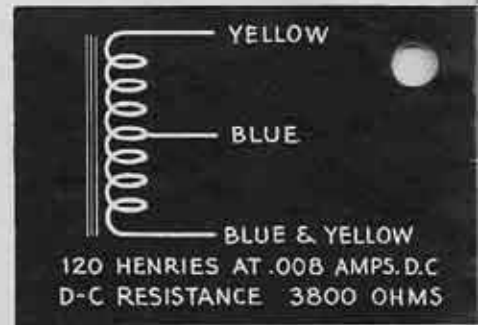

Connect yellow to RCA-6C5 plate



## VERTICAL OSCILLATION TRANSFORMER

A scientifically designed transformer for low-frequency blocking-oscillator circuit. Gives best efficiency at 60 cycles. Size: H.  $2\frac{3}{8}$ ", Base  $2\frac{1}{4}$ " square, Diameter  $2\frac{1}{8}$ ".

Stock No. 9834

Net Price \$3.00

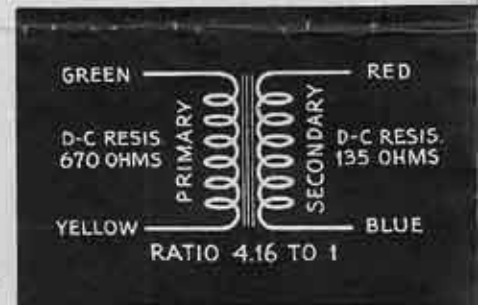

Connect green to plate, yellow to R-3, red input and blue to grid capacitor



## HORIZONTAL OSCILLATION TRANSFORMER

This transformer is designed for high frequency blocking oscillator circuits. It has high efficiency at frequency of 13,200 cycles. Size: H.  $2\frac{3}{4}$ ", Base  $2\frac{1}{4}$ " square, Diameter  $2\frac{1}{8}$ ".

Stock No. 9835

Net Price \$3.00

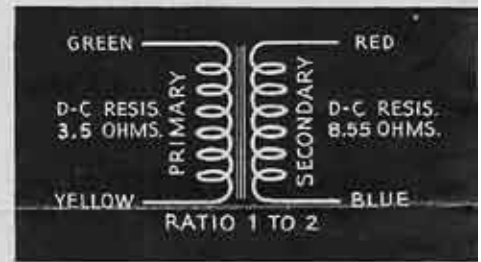

Connect green to grid condenser, yellow to R-1, red to R-4, blue to plate

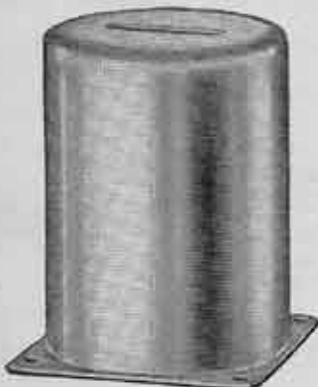

## HORIZONTAL OUTPUT TRANSFORMER

Has correct characteristics to supply a 13,200-cycle saw-tooth current wave to deflecting yoke. Core and coil rubber mounted to eliminate noise. Size: H.  $3\frac{1}{4}$ ", Base  $2\frac{1}{4}$ " square, Diameter  $2\frac{5}{8}$ ".

Stock No. 9836

Net Price \$9.50

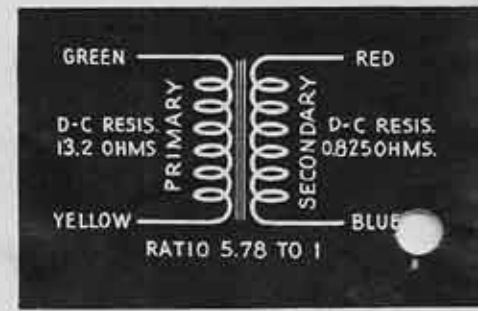

Connect green to plate, yellow to +300 v., red to yoke, blue to centering control



## POWER SUPPLY CAPACITOR

For RCA 1800 Kinescope. A high quality 6,000 volt unit containing two .03 mfd. capacitors. High-voltage terminals provided for one center and two outside connections. Oil-filled construction to insure long life. Size: H.  $6\frac{1}{2}$ ", W. 2", D.  $2\frac{3}{8}$ ". Base  $3" \times 2\frac{3}{8}"$ .

Stock No. 9837

Net Price \$11.75

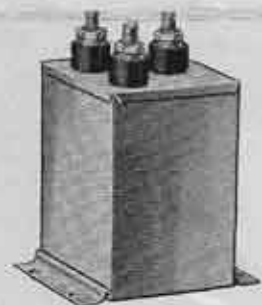
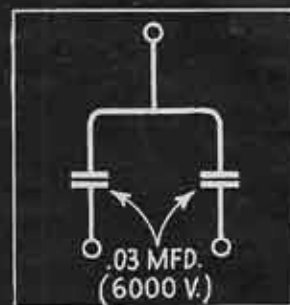

## POWER SUPPLY CAPACITOR

For RCA 1801 Kinescope. A high quality capacitor containing one .025 mfd. 4,000 volt unit and one .05 mfd. 3,500 volt unit. Oil-filled construction with high-voltage terminals. Size: H.  $3\frac{1}{8}"$ , W.  $2\frac{3}{8}"$ , D.  $2\frac{1}{8}"$ , Base  $3" \times 2\frac{3}{8}"$ .

Stock No. 9840

Net Price \$5.50

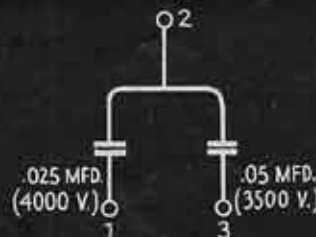

## POWER SUPPLY REACTOR

A newly designed high inductance reactor for Kinescope filter circuits. Insures good regulation in power supply circuit when used in conjunction with Stock Nos. 9837 or 9840 Power Supply Capacitor. Size: H. 4", Base  $3\frac{1}{4}"$  square, Diameter  $3\frac{1}{8}"$ .

Stock No. 9838

Net Price \$4.75



## RCA KINESCOPES

These RCA Kinescopes are especially designed for television reception. They give a clear picture having a slight yellowish hue and are designed to give long and satisfactory service.

RCA 1800 9-in. Kinescope, Net Price \$60.00

RCA 1801 5-in. Kinescope, Net Price \$40.00



# RCA KINESCOPE CIRCUIT DIAGRAMS

The following schematic diagrams show the recommended methods of using the RCA parts previously described in conjunction with Kinescope deflecting circuits. The parts not included in the previous listings are standard items that may be procured from any RCA Parts distributor. *The constants used in these diagrams have been chosen so as to insure best results from the component parts listed in this bulletin.*

**CAUTION**—Rectifier sockets must be insulated for Kinescope second anode voltage.

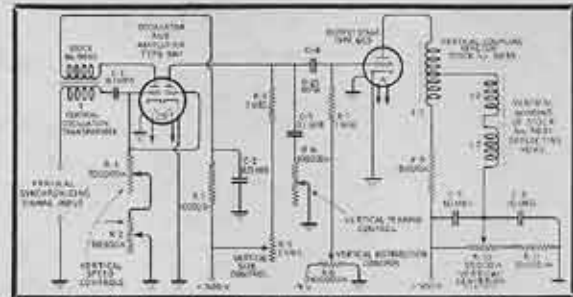

Vertical Deflecting Circuit for either RCA 1800 or 1801 Kinescope

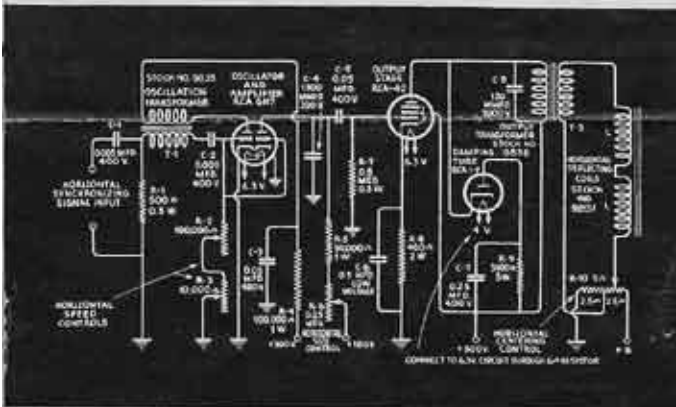

RCA 1801 Horizontal Deflecting Circuit

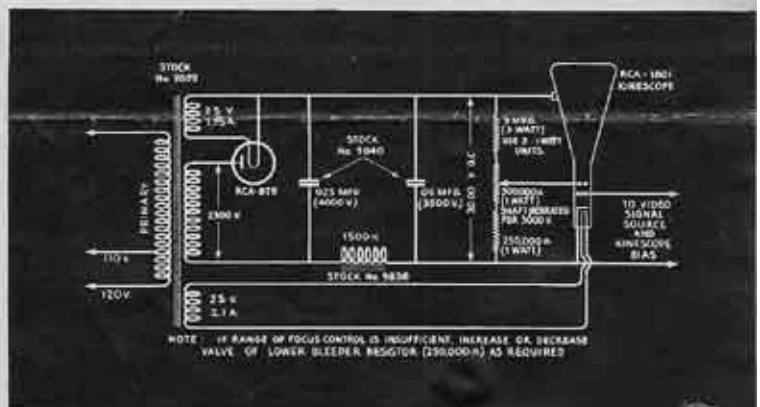

RCA 1801 Power Supply Circuit

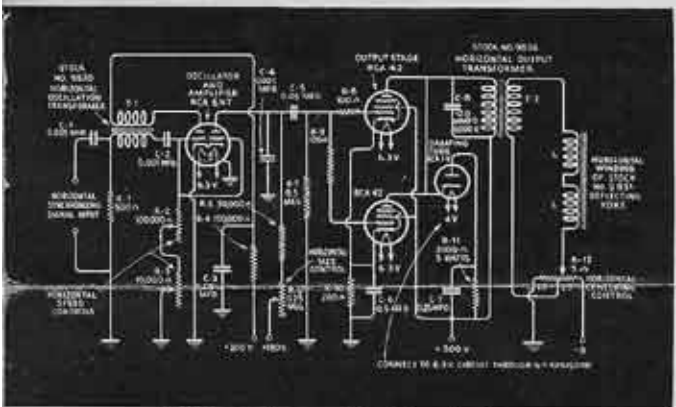

RCA 1800 Horizontal Deflecting Circuit

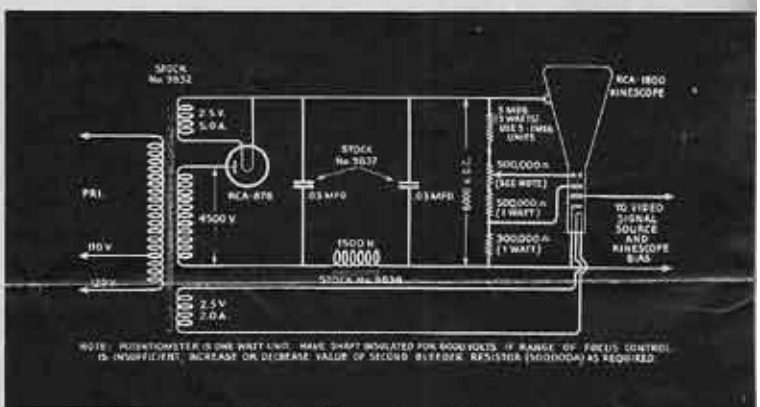

RCA 1800 Power Supply Circuit

## ALLIED RADIO CORPORATION

833 WEST JACKSON BLVD.

CHICAGO, ILLINOIS



# RCA PARTS DIVISION

RCA Manufacturing Co., Inc., Camden, N. J. • A Service of Radio Corporation of America

Form 2853

The parts described in this circular are licensed only for amateur and experimental radio use.

Printed in U. S. A.